

# Lupo

Made in Italy

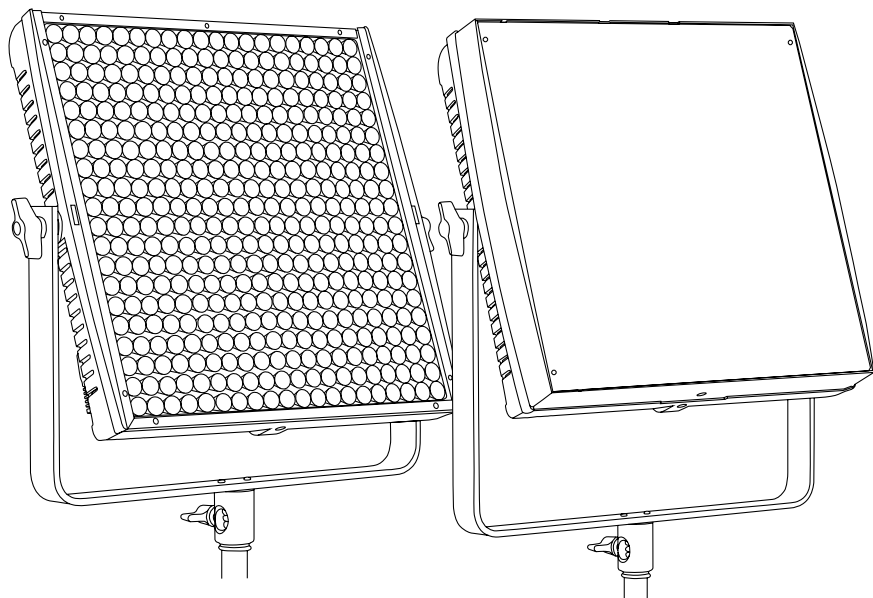

# Superpanel 30

---

## User Manual

---

SUPERPANEL 30  
SUPERPANEL SOFT 30  
SUPERPANEL DUAL COLOR 30  
SUPERPANEL SOFT DUAL COLOR 30

### **SAFETY PRECAUTIONS:**

Do not operate the equipment before studying the instruction manual and the accompanying safety precautions. Make sure that Lupo Safety Instruction is always included with the equipment! Lupo products are intended for professional use. Do not place or use the equipment where it can be exposed to moisture, extreme electromagnetic fields or in areas with flammable gases or dust! Do not expose the equipment to hasty temperature changes in humid condition as could lead to condensation water in the unit. Equipment must only be serviced, modified or repaired by authorized. Dealers or the factory.

### **CAUTION - BURN HAZARD - HOT PARTS**

Do not touch hot parts with bare fingers! LED bulbs and certain metal parts emit strong heat when used!  
Do not point lamps too close to persons.  
Always use the fixtures with the front part closed.

### **NOTICE - EQUIPMENT OVERHEATING RISK**

Do not obstruct ventilation by placing filters, diffusing materials, etc. over inlets and outlets of the equipment ventilation or directly over glass cover or LED bulbs.

### **FINAL DISPOSAL**

Equipment contains electrical and electronic components that could be harmful to the environment.  
Equipment may be returned to Lupo distributors free of charge for recycling according to WEEE.

Follow local legal requirements for separate disposal of waste, for instance WEEE directive for electrical and electronic equipment on the European market, when product life has ended.

### **MAINTENANCE AND CARE**

Please do not forget that the safe operation of lampheads also includes their maintenance and care.

A visual inspection should be conducted before every use and an inspection of electrical safety should be conducted at least once every 12 months.

### **WARRANTY**

The warranty period for Lupo products and those marketed by Lupo is twelve months from the date of delivery. Lupo guarantees that the goods it supplies are well manufactured and of good quality. The warranty guarantees the repair of any parts that show acknowledged defects in materials, construction or workmanship during the warranty period. The guarantee excludes any liability for direct or indirect damage of any kind and for any reason, for which Lupo will therefore not be required to pay compensation. The customers shall see to deliver the parts that need repair or replacement to Lupo's works at their own expense and risk. The repaired or replacement parts shall be delivered by Lupo ex-works. The customers will be charged for materials and labor or replacement of the product after the expiration of the warranty period.

### **⚠ WARNING:**

When hanging the fixture from higher position, please make sure you use safety cable to attach the barndoors to the yoke of the panel.

Barndoors should always be used to secure the fixture and the application when used in this way.

Another safety cable should be used to secure the fixture to the mounting pipe or truss.

Both safety cables must be properly dimensioned for the fixture and the application when the fixture is operated in hanging position please ensure that the accessories are installed correctly with top latch locked.

*Thanks for having purchased **Lupo** products. All the products are made in Italy and all the efforts have been put to keep the quality standards high. We hope this product can help you in your job and make your life easier as a professional. We also hope you will enjoy its use and we would be happy to receive your feedback about it.*

# Instructions

- Device for indoor use only.
- Maximum ambient temperature: 35 °C.
- Make sure power supply plug is suitable to power required.
- As prescribed by international regulations, a safety cable must be used when the fixture is suspended from ceiling.
- To switch on the light push the on/off button.
- Superpanel models are equipped with new generation high quality poweredleds.

## Getting Started

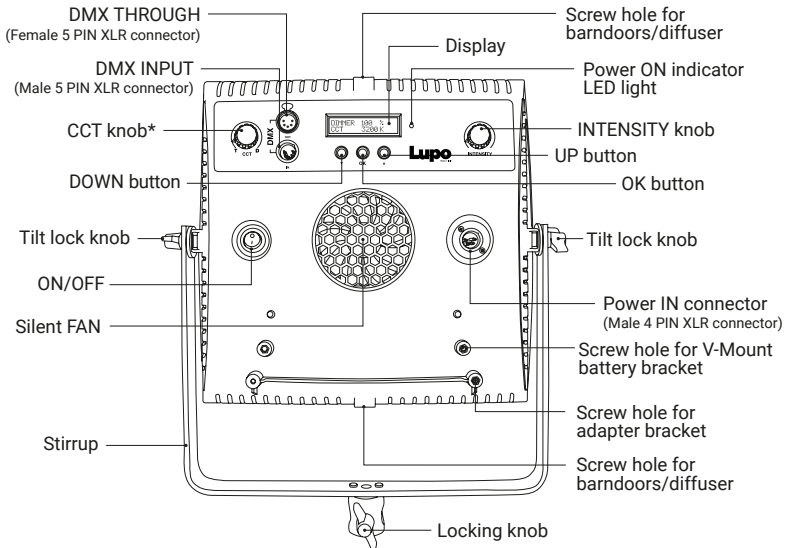

\* Feature included only Dual Color version.

## Turning on the Superpanel

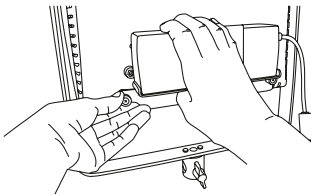

- 1** Place the AC Adapter in the mounting bracket via the 2 captive screws to the bottom of the SUPERPANEL 30 fixture.

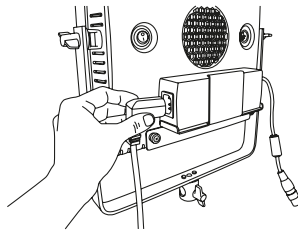

- 2** Insert the power cord cable into the AC adapter and connect the fixture to the power plug.

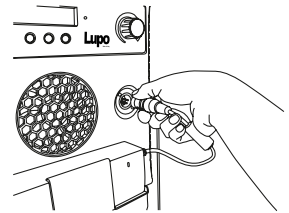

- 3** Insert the DC XLR 4 pin connector into the input jack on the SUPERPANEL 30 and **power on** the fixture.

# Functioning

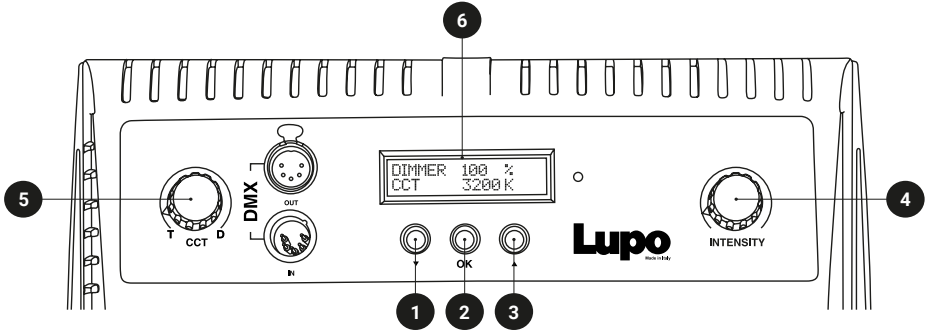

## CONTROL PANEL

- In current mode press the « OK » ② button to enter the main MENU.
- In the sub-menus press the « OK » ② button to confirm a selection.
- Use the « ▼ » ① or « ▲ » ③ buttons to navigate in the main MENU and sub-menus.
- Use the « INTENSITY » ④ knob to adjust the **light intensity from 0 to 100%**.
- Use the « CCT » ⑤ knob to adjust the light mode parameters.
- Display ⑥.

⚠ **ATTENTION:** The **light intensity** level will be adjustable from **0 - 50%** if the **FAN** is **OFF**.  
The value on the display flashes.

## MANUAL OPERATION

1. Press the « OK » ② button to enter the main MENU.
2. Select **MANUAL** by pressing the « OK » ② button.
3. Select the light mode between **CCT/MONOCOLOR MODE\*** and **EFFECT MODE** with the « ▼ » ① or « ▲ » ③ button, press « OK » ② to confirm selection.
4. See **LIGHT MODES**.

## DMX OPERATION

1. Press the « OK » ② button to enter the main MENU.
2. Select **DMX** with the « ▲ » ③ button, press « OK » ② button to confirm selection.
3. Select the light mode between **CCT/MONOCOLOR MODE\*** and **EFFECT MODE** with the « ▼ » ① or « ▲ » ③ button, press « OK » ② to confirm selection.
5. Select the DMX channel, use the « ▼ » ① and « ▲ » ③ buttons to change DMX ADDRESS in ascending or descending order between 1 and 512. The number shown on the display ⑥ is the selected channel to communicate with the control desk.
6. See **DMX PROTOCOL MANUAL** to DMX channel specification.

**NOTE:** The symbol - ! - on the display indicates that there is **no DMX signal**.

\* The name of the mode changes according to the Superpanel 30 version: **mono** or **dualcolor**.

## DMX OPERATION - Advanced Settings

1. Press the « **OK** » ② button to enter the main MENU.
2. Navigate through the main MENU with the « ▼ » ① or « ▲ » ③ buttons to the **DMX** item, select by pressing the « **OK** » ② button.
3. Press the « ▼ » ① or « ▲ » ③ buttons to select **DMX ADVANCED**, press « **OK** » ② button to confirm selection.
4. Select one of the options between the **DMX BIT** and **DMX SIGNAL LOSS**, press « **OK** » ② to confirm the selection.

### **DMX BIT:**

Resolution of the DMX control. 8bit 1 channel per function and 16 bit 2 channels per function.

1. Select the **DMX BIT** item by pressing the « **OK** » ② button.
2. Use the « ▼ » ① or « ▲ » ③ buttons to choose between **8 bit / 16 bit**, press the « **OK** » ② button to confirm the selected setting. See **DMX PROTOCOL**.

### **DMX SIGNAL LOSS:**

This feature allows to choose the device's behaviour in case of a DMX signal loss.

1. Select the **LOSS DMX SIGNAL** item with the « **OK** » ② button.
2. Use the « ▼ » ① or « ▲ » ③ buttons to select the device's behaviour between **BLACK OUT / SETTINGS LAST / SETTINGS 1min**, press the « **OK** » ② button to confirm the setting.

**Black out:** The device switches off.

**Settings Last:** The values of the last selected setting are maintained over time until the device is switched off.

**Settings 1min:** The values of the last selected settings will be maintained for one minute and then the device will switch off.

## LIGHT MODES

### **A. MONOCOLOR MODE:** Available only Monocolor version.

It allows you to adjust the light intensity. *This is the default setting.*

1. Use the « **INTENSITY** » ④ knob to adjust the **light intensity from 0 to 100%**.

### **B. CCT MODE:** Available only Dual Color version.

Warm and cold white control mode. It allows you to adjust colour temperature (CCT) and light intensity. *This is the default setting.*

1. Use the « **INTENSITY** » ④ knob to adjust the **light intensity from 0 to 100%**.
2. Use the « **CCT** » ⑤ knob to adjust the **colour temperature (CCT) values from 3200K to 5600K**.

### **C. EFFECT MODE:** Available only in manual operation.

**STROBE effect:** The strobe effect is applied to the last set parameters of the MONOCOLOR or CCT mode.

1. Use the « **INTENSITY** » ④ knob to adjust the **light intensity from 0 to 100%**.
2. To adjust the **effect frequency from 1 Hz to 25 Hz** use the « ▼ » ① or « ▲ » ③ buttons for monocolour version, for dual-color version use the « **CCT** » ⑤ knob.

**TELEVISION / PAPAARZZI / LIGHTNING effects:** Available only Dual Color version.

1. Use the ④, ⑤ knob and « ▼ » ① or « ▲ » ③ buttons to adjust the effect setting values. See table below.

EFFECT	④ INTENSITY	⑤ CCT	« ▾ » ① « ▴ » ③
TELEVISION	Light Intensity from 0 to 100%	White range - 1 / 2 / 3 / 4	Frequency - 4 to 24 Hz
PAPARAZZI		Flashing Interval - 1 to 10	Bulb type - 0 / 1 / 2
LIGHTNING		Color Temperature	Lightnings Interval - 1 to 20

**⚠ ATTENTION - Only to STROBE effect in DUAL COLOR version:**

1. The strobe effect is **AVaiLABLE ONLY IN MANUAL OPERATION**.
2. The strobe effect is applied to the parameters of the last configured CCT/HSI/RGBW/ PRESET mode.
3. The STROBE effect is **NOT WORK** if TELEVISION, PAPARAZZI or LIGHTNING effects are in functioning.

**DMX OPERATION - DMX protocol**

The Superpanel 30 can be used with **8 bit** (1 channel per function) and **16 bit** (2 channels per function). The Superpanel 30 uses consecutive channels starting from the DMX address set on the panel used as reference for the connection to the control desk. Please take the above into consideration when using many units of Superpanel 30 to avoid overlaps.

DMX Channel Protocol - 8 bit		
MODE	CHANNELS USED	DMX CHANNEL POSITION
CCT or MONOCOLOR	1 / 2*	1. DIMMER
		2. COLOR TEMPERATURE*
TELEVISION*	3	1. DIMMER
		2. WHITE RANGE
		3. FREQUENCY
PAPARAZZI*	3	1. DIMMER
		2. INTERVAL
		3. BULB TYPE
LIGHTNING*	3	1. DIMMER
		2. COLOR TEMPERATURE
		3. INTERVAL
DMX Channel Protocol - 16 bit		
MODE	CHANNELS USED	DMX CHANNEL POSITION
CCT or MONOCOLOR	2 / 4*	1. DIMMER - byte 1
		2. DIMMER - byte 2
		3. COLOR TEMPERATURE - byte 1*
		4. COLOR TEMPERATURE - byte 2*
TELEVISION*	6	1. DIMMER - byte 1
		2. DIMMER - byte 2
		3. WHITE RANGE - byte 1
		4. WHITE RANGE - byte 2
		5. FREQUENCY - byte 1
		6. FREQUENCY - byte 2
PAPARAZZI*	6	1. DIMMER - byte 1
		2. DIMMER - byte 2
		3. INTERVAL - byte 1
		4. INTERVAL - byte 2
		5. BULB TYPE - byte 1
		6. BULB TYPE - byte 2
LIGHTNING*	6	1. DIMMER - byte 1
		2. DIMMER - byte 2
		3. COLOR TEMPERATURE - byte 1
		4. COLOR TEMPERATURE - byte 2
		5. INTERVAL - byte 1
		6. INTERVAL - byte 2

\*Channel in use only the Dual Color version.

## DEVICE SETTINGS

1. Press the « OK » ② button to enter the main MENU.
2. Navigate through the MENU using the « ▼ » ① or « ▲ » ③ buttons, select **DEVICE SETTINGS**, press the « OK » ② button to confirm the selection.
3. Navigate through the **FAN / DISPLAY / MENU VIEW / FILTER / LINEARIZATION** functions, use the « ▼ » ① and « ▲ » ③ buttons to select the desired function and press « OK » ② to confirm the selection.
4. Within each function select the option to be activated, use the « ▼ » ① and « ▲ » ③ buttons to select one between the options, press « OK » ② to activate it.

**Fan:** Fan operation. **ON / OFF.**

When the fan is **OFF** the **light intensity** will be adjustable between **0 and 50%**.

**Display:** Time during which the display backlight stays on. **30sec / 1min / ALWAYS ON.**

**Menu View:** **Type the main MENU**, sub-menus and functions to show. **ONLY MANUAL / ONLY DMX / MANUAL/DMX.**

**Filter:** It is the speed response of the system (smooth factor).

**FULL SPEED / NORMAL SPEED / HIGH SPEED / LOW SPEED.**

**Linearization:** Linearization is the compensation curve for the human eye's perception of the luminous intensity emitted as a function of the required power. Required power = dimmer value on the display. **LINEAR / EXPONENTIAL / LOGARITHMIC.**

**Linear:** No compensation, the intensity of the light is directly proportional to requested power.

**Exponential:** The light intensity increases from 0 to 100 exponentially.

**Logarithmic:** The light intensity increases from 0 to 100 logarithmically.

## RESET DEVICE

1. Press the « OK » ② button to enter the main MENU.
2. Select **RESET DEVICE** using the « ▼ » ① or « ▲ » ③ buttons, press the « OK » ② button to confirm the selection.
3. Select **YES** with the « ▼ » ① or « ▲ » ③ buttons, press « OK » ② to confirm the selection.
4. The device will ask for further confirmation, select **YES** by pressing the « OK » ② button. **THE DEVICE WILL RETURN TO FACTORY DEFAULT SETTINGS.**

### FACTORY DEFAULT SETTING

#### MANUAL OPERATION

MODE: CCT/MONOCOLOR

#### DMX OPERATION

MODE: CCT

BIT: 8 BIT

DMX SIGNAL LOSS: Settings 1 MIN

#### DEVICE SETTINGS

FAN: ON

DISPLAY: 1 min

MENU VIEW : Manual/DMX

FILTER : Normal Speed

LINEARIZATION: Linear

# Package Contents

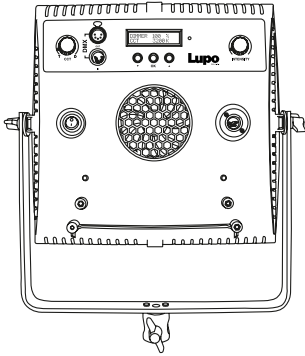

**Superpanel 30**

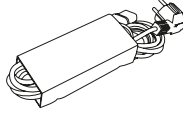

**AC Power  
Cord Cable**

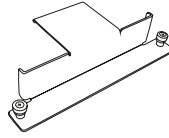

**AC Adapter  
Mounting Bracket**

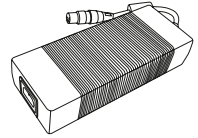

**AC Adapter**  
AC input: 100 V - 240 V  
DC output: 24 V

**⚠ ATTENTION:** Please keep the original package of the product in a safe place for warranty reasons.

# MENU e submenus

- Select **"EXIT"** to return to the current mode.
- Select **"BACK"** to return to the previous menu.
- **After 1 minute of inactivity in the menu, the device automatically exits and returns to the last selected mode.**

